

*phoenix*  
SAFE COMPANY LIMITED



KS0210 SERIES  
PALM  
USER MANUAL v3.0

# What's Included



**1 x KeyBox**



**1 x HELLO Card**



**2 x Screw Cap**

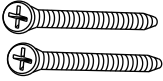

**2 x Mounting Screws**



**2 x Screws Anchors**



**1 x Reset Tool**

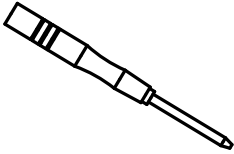

**Screw Driver x 1**

# Specification

<b>Model</b>	KS0210 SERIES PALM KEY STORE
<b>Material</b>	Body Zinc Alloy, SUS304
<b>Battery</b>	4 x AAA Alkaline Battery (not included)
<b>Unlock Mechanism</b>	Bluetooth, PIN Code, App
<b>Jump Start</b>	USB-C

**Front**

**Inside**

**Back**

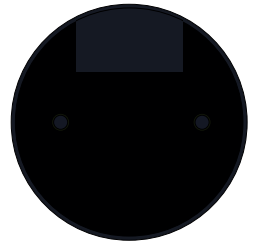
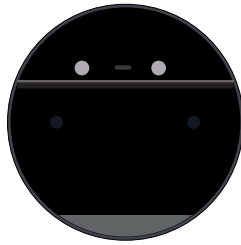
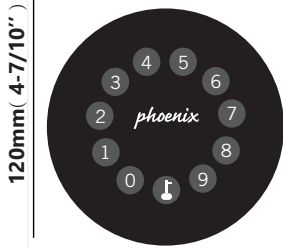

120mm ( 4- 7/10'' )

120mm ( 4- 7/10'' )

120mm ( 4- 7/10'' )

**Depth**  
22mm ( 4/5 '' )

120mm ( 4- 7/10'' )

# Features

## Lock&Unlock



### Administrator Unlock

Set a Master Administrator PIN for Unlocking, settings, operations etc. and only the administrator could change the administrator PIN code.



### Anti-peeping

Add up to 10 digits before and after PIN code to intensify your PINs.

## Mobile Control



### Bluetooth one-touch unlock

With your Mobile you could unlock the KeyBox by tapping the "🔒" on the App.



### Mobile Administrator

Set Administrator PIN Codes from your Mobile to unlock, add users, delete users, etc.

## Battery



### Battery Life

4 AAA batteries, the life cycle will be more than 12 months, please use good batteries.



### Low Consumption

BLE broadcasting turns to sleep mode if no operations.

## Emergency



### Jump Start

When the power is down and use USB-C to jump start the lock and get it unlocked



### System Lockdown

The lock will be lockdown for 5 minutes if continuously enter wrong PINs for 5 times.



### User Unlock

This KeyBox allows to add up to 100 user PIN codes for your family, friends and visitors.

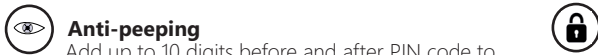

### Auto Locking

If there are no opening motions in 10 seconds the box will be automatically locked.



### Offline Unlock

You could generate offline code through mobile App, for scheduled access, parcel delivery, housekeeping, etc.

## Quick Start

### Step 1 > Install Battery

>. Remove the (4) screws on the battery cover

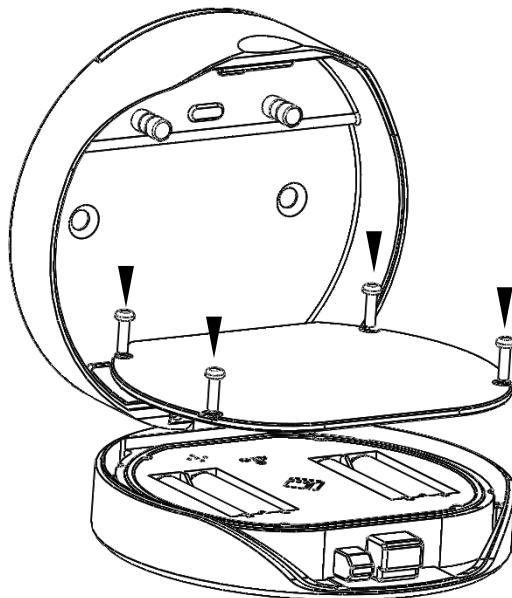

>. Put 4 AAA batteries into the battery dock.

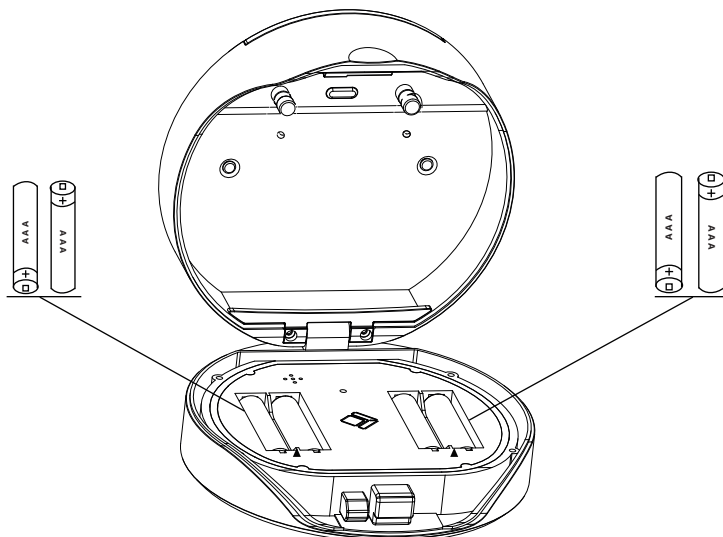

## Step 2>Download Mobile App

>1. Scan QR Code below and download the App and turn on your mobile Bluetooth



## Step 3>Add Device

>1.Go to App Home page, click Add Device or click "+" on the upper right.

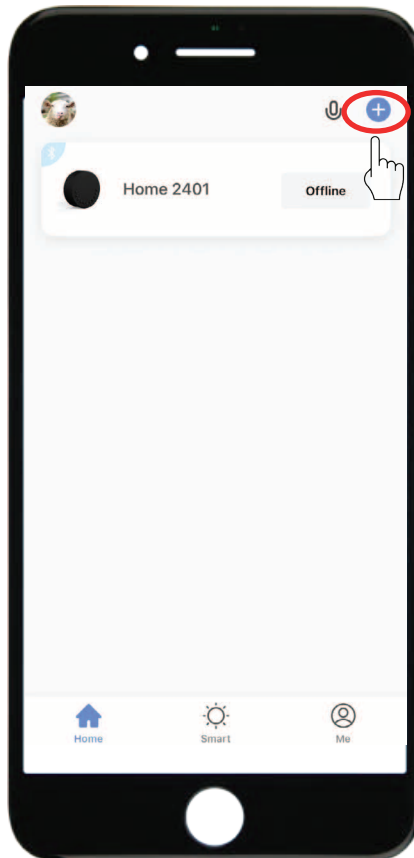

> 2. Press **⏏** +9+ **⏏** and enter Admin password + **⏏** , when the light slowly blinks in blue the KeyBox is ready to pair.



>3. You will see the detected device and click "Go to add".

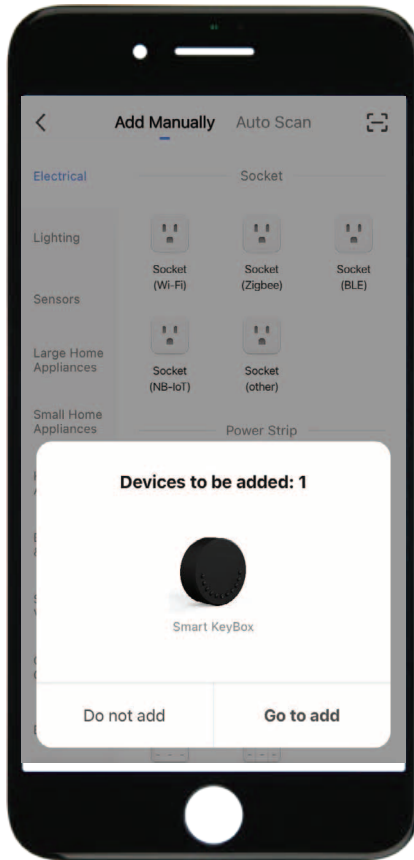



>4. Connecting, you need to wait for few seconds to let it finish.

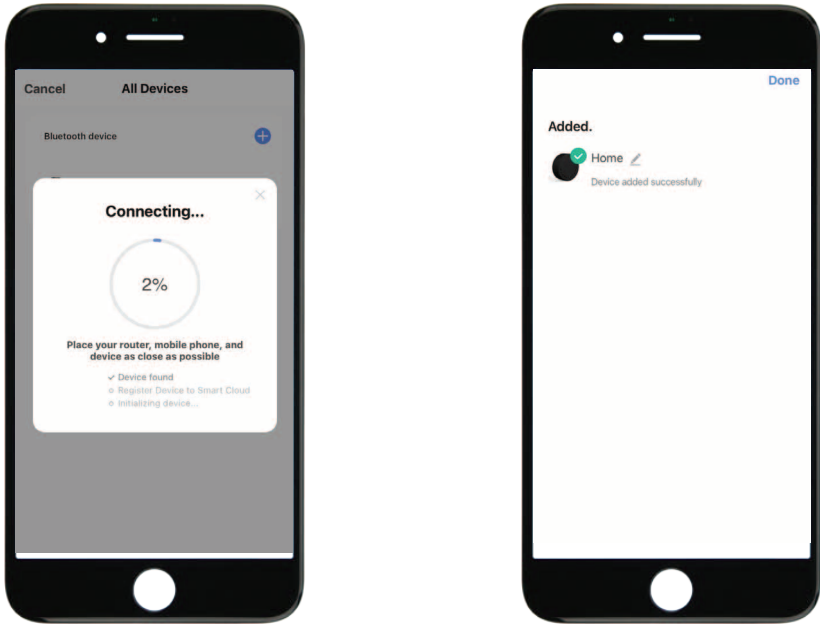

>5. Device added

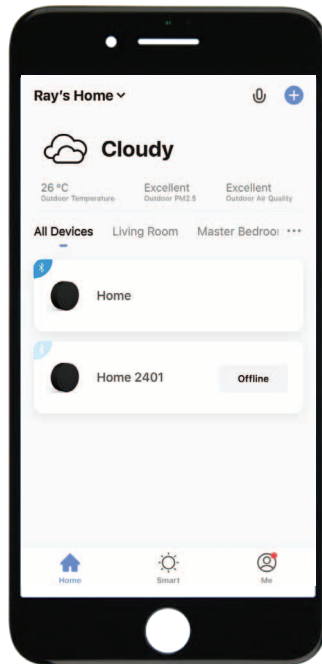

## Step 4>Change Admin Password-Initial Admin Password:123456

>1. Press  and hold for 3 beeps

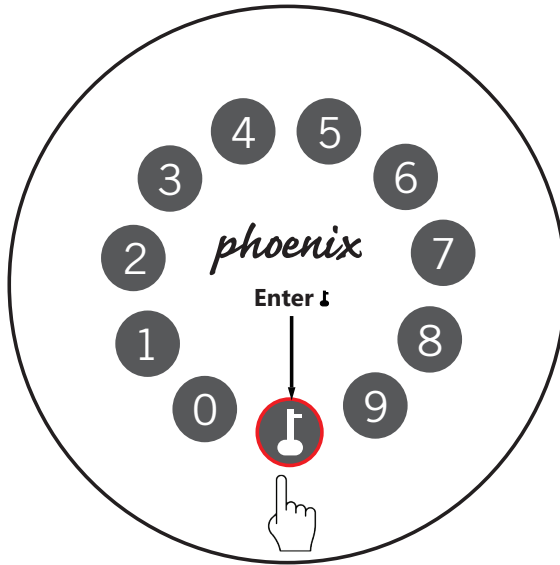

>2. Right after the 3 beeps please key in:

Initial Admin Password + +new admin password+ +new admin password+ 

# Mechanical Instructions

## Password & Factory Mode:

### 1. Password Length

- Password must be 6 digits (no more no less)

### 2. Add User Password

- Click **⏏**+**0**+ **⏏** until the blue light blinks
  - >. Enter admin password and press **⏏**.
  - >. Enter new user password and press **⏏**.
  - >. Enter new user password again and press **⏏**.
  - >. When the light blinks green, user password has been set.

### 3. Delete User Password

- Press **⏏** + **2** + **⏏** until the blue light blinks
  - >. Enter admin password and do not press any other button
  - >. Enter the user password you wish to delete and press **⏏**
  - >. When the **⏏** (Enter button) blinks in green the password has been deleted.

### 4. Delete All User Password

- Press **⏏** + **00000** + **⏏** until the blue light blinks
  - >. Enter admin password and press **⏏**
  - >. When the **⏏** (Enter button) blinks in green, all passwords have been deleted.

### 5. Virtual digits-Anti Peeping

- Add any digits before and after the correct password the KeyBox unlock as always

### 6. System Lockdown

- KeyBox will Lockdown for 5 minutes if entering wrong password continuously 5 times

### 7. Reset Factory Mode

- Press and hold the reset button for 5 seconds and with a long beep

## Bluetooth broadcasting & re-connecting:

- Bluetooth broadcasting will turn to sleep mode if no operations within 1 minute.
- Press any key to activate the Bluetooth, App&Device will get reconnected each other.

# App Instructions

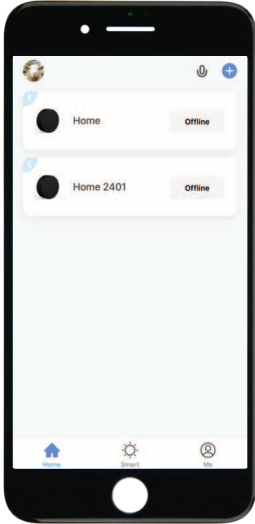

- ☑ You will see all devices and rooms on the home page.
- ☑ Tap the Device to start operating.
- ☑ Tap “Me” at the bottom to manage your home.

- ☑ Touch the lock sign to unlock and lock.
- ☑ Tap “Bell” sign to check the alarm records.
- ☑ Tap “Member Management” to add or delete members.
- ☑ Tap “opening record” to check opening logs.
- ☑ Tap “Intelligent Linkage” to turn on and off go home mode.
- ☑ Tap “Set” to manage passwords

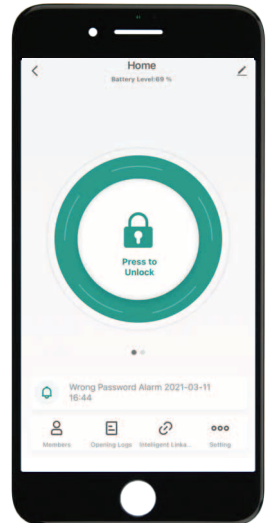

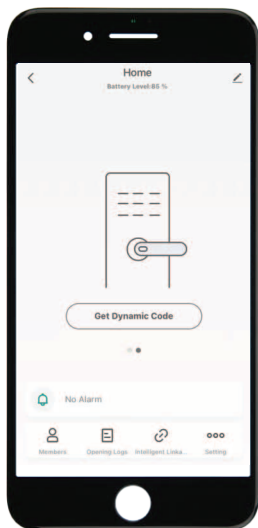

☑ Tap “Get dynamic code” to get a code.

☑ Tap “copy code” and send it to friend or family.

☑ Tap “Pen” sign to edit your personal information.

☑ Go to “Members” to add family or other members

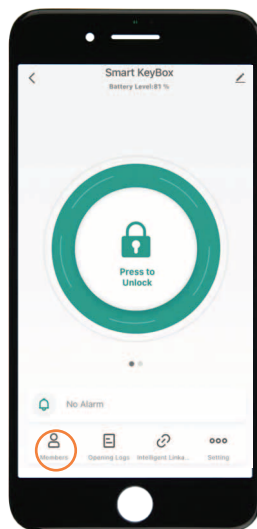

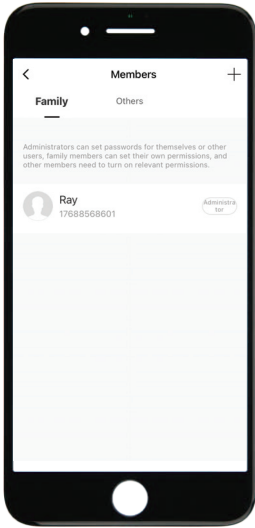

☒ Tap “+” to add family member or other members

☒ Tap “Add it now” under Family to add family members.

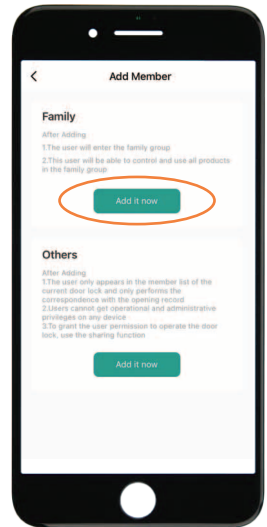

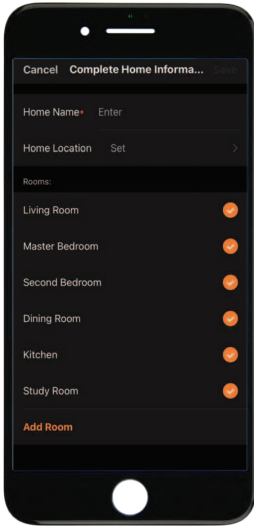

- ☒ Owner need to complete the Home information before adding any family member if required
- ☒ The member need to be registered to the App before adding as a family member

- ☒ Fill up member information and set the role of the member
- ☒ Tap "Save" to complete and the member will be able to operate the device on his App

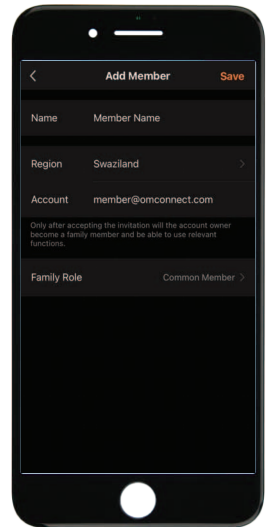

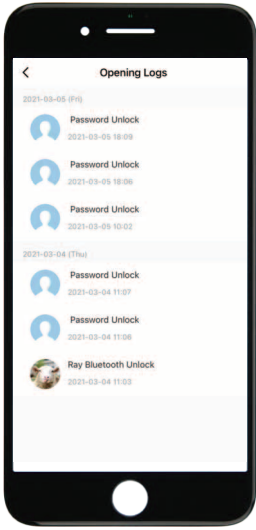

- ☑ Go to "Opening Logs" to check the unlocking history
- ☑ With this feature you will be able to find out when and who unlocked the KeyBox

- ☑ Go to "Intelligent Linkage" to set more smart functions
- ☑ Tap the green bar to turn on "Family go home" function
- ☑ Tap the orange bar to turn on "Door lock alarm" function
- ☑ You will get notification if user unlocked with Bluetooth
- ☑ Go to "me" homepage and go to message center to check the records.

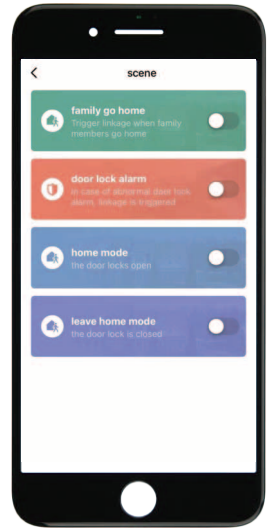



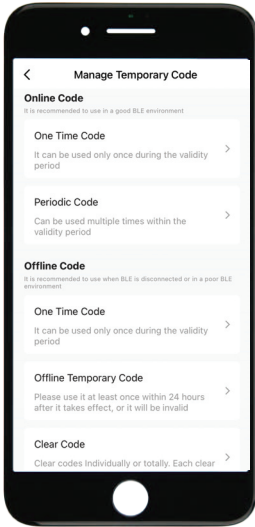

☑ Tap “password management” to add or remove codes.

☑ Tap “Temporary code” to manage online and offline codes.

☑ Tap “one-time code” under Online Code to set an online one time code.

☑ Tap “periodic Code” under Online Code to set an online code which will be available in a period of time.

☑ Tap “One-Time Code” under Offline Code to generate a one time offline code which will be a 10 digit code and use it when the device is offline.

☑ Tap “Offline Temporary Code” under Offline Code to generate an offline code (10 digits) which will be available in a period of time, and use when the device is offline or Bluetooth disconnected with device.

☑ Tap “Clear Code” to generate a code (10 digits) which is able to clear Codes that need to be invalid or clear all codes.

☑ Please note if the code less than 10 digits you need to regenerate a new code, the code must be 10 digits.

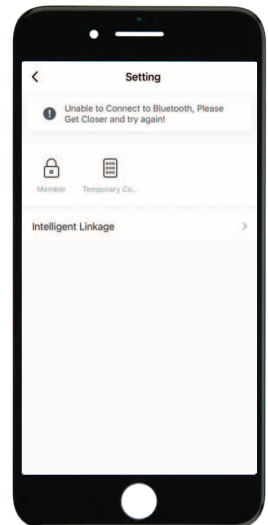

*phoenix*  
SAFE COMPANY LIMITED

[www.phoenixsafe.com](http://www.phoenixsafe.com)